

NORDMENDE™

LARDER

Instruction booklet

RTL266WHA+

Index

BEFORE USING YOUR FRIDGE	2
General warnings	2
Old and out-of-order fridges	4
Safety warnings	4
Installing and Operating your Fridge	5
Before Using your Fridge	5
USAGE INFORMATION	6
Thermostat Setting	6
CLEANING AND MAINTENANCE	7
Defrosting	8
Replacing The Bulb	8
SHIPMENT AND REPOSITIONING	9
Repositioning the Door	9
BEFORE CALLING SERVICE	9
THE PARTS OF THE APPLIANCE AND THE COMPARTMENTS	11

CHAPTER 1. BEFORE USING YOUR FRIDGE

General warnings

WARNING: Keep ventilation openings, in the appliance enclosure or in the built-in structure, clear of obstruction.

WARNING: Do not use mechanical devices or other means to accelerate the defrosting process, other than those recommended by the manufacturer.

WARNING: Do not use electrical appliances inside the food storage compartments of the

appliance, unless they are of the type recommended by the manufacturer.

WARNING: Do not damage the refrigerant circuit.

WARNING: To avoid a hazard due to the instability of the appliance, it must be fixed in accordance with the instructions.

- If your appliance uses R600 as a refrigerant – you can learn this information from the label on the cooler- you should be careful during shipment and montage to prevent your appliance's cooler elements from being damaged. Although R600a is a environmental friendly and natural gas, as it is explosive, in case of a leakage to be occurred due to a damage in the cooler elements move your fridge from open flame or heat sources and ventilate the room where the appliance is located for a few minutes.
- While carrying and positioning the fridge, do not give damage to the cooler gas circuit.
- Do not store explosive substances such as aerosol cans with a flammable propellant in this appliance.
- This appliance is intended to be used in household and similar applications such as;

- staff kitchen areas in shops, offices and other working environments
- farm houses and by clients in hotels, motels and other residential type environments
- bed and breakfast type environments;
- catering and similar non-retail applications
- If the socket does not match the refrigerator plug, it must be replaced by the manufacturer, its service agent or similar qualified persons in order to avoid a hazard.
- This appliance is not intended for use by persons (including children) with reduced physical, sensory or mental capabilities, or lack of experience and knowledge, unless they have been given supervision or instruction concerning use of the appliance by a person responsible for their safety. Children should be supervised to ensure that they do not play with the appliance.
- A specially grounded plug has been connected to the power cable of your refrigerator. This plug should be used with a specially grounded socket of 16 amperes. If there is no such socket in your house, please have it installed by an authorized electrician.
- This appliance can be used by children aged from 8 years and above and persons with reduced physical, sensory or mental capabilities or lack of experience and knowledge if they have been given supervision or instruction concerning use of the appliance in a safe way and understand the hazard involved. Children shall not play with the appliance. Cleaning and user maintenance, shall not be made by children without supervision.
- If the supply cord is damaged, it must be replaced by the manufacturer, its service agent or similar qualified persons in order to avoid a hazard.

Old and out-of-order fridges

- If your old fridge has a lock, break or remove the lock before discarding it, because children may get trapped inside it and may cause an accident.
- Old fridges and freezers contain isolation material and refrigerant with CFC. Therefore, take care not to harm environment when you are discarding your old fridges.

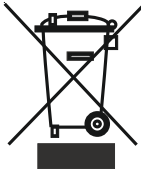

Please ask your municipal authority about the disposal of the WEEE for the reuse, recycle and recovery purposes.

Notes:

- Please read the instruction manual carefully before installing and using your appliance.
We are not responsible of the damage occurred due to misuse.
- Follow all instructions on your appliance and instruction manual, and keep this manual in a safe place to resolve the problems that may occur in the future.
- This appliance is produced to be used at houses and it can only be used in house and for the specified purposes. It is not suitable for commercial or common use. Such use will cause the guarantee of the appliance to be cancelled and our company will not be responsible for the losses to be occurred.
- This appliance is produced to be used in houses and it is only suitable for cooling / storing foods. It is not suitable for commercial or common use and/or for storing substances except for food. Our company is not responsible for the losses to be occurred in the contrary case.

Safety warnings

- Do not use multiple receptacles or extension cord.
- Do not plug in damaged, torn or old plugs.



- Do not pull, bend or damage the cord.
- This appliance is designed for use by adults, do not allow children to play with the appliance or let them to hang over the door.
 - Do not plug-in or out the plug from the receptacle with wet hands to prevent electrocution!
- Do not place explosive or flammable material in your fridge for your safety. Place drinks with higher alcohol amount vertically and by closing their necks tightly in the fridge department.
- Do not cover the body or top of fridge with lace. This effects the performance of your fridge.

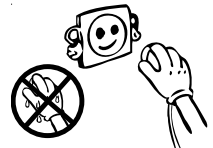

- Fix the accessories in the fridge during transportation to prevent damage to accessories.



Installing and Operating your Fridge

- Operating voltage for your fridge is 220-240 V at 50Hz.
- We do not take the responsibility of the damages that occur due to ungrounded usage.
- Place your fridge in a place that it would not be exposed to direct sunlight.
- Your appliance should be at least 50 cm away from stoves, ovens and heater cores, and should be at least 5 cm away from electrical ovens.
- It should never be used outdoors or left under the rain.
- When your fridge is placed next to a deep freezer, there should be at least 2 cm between them to prevent humidity on the outer surface.
- Do not place anything on your fridge, and install your fridge in a suitable place so that at least 15 cm is available on the upper side.
- Fit the plastic wall spacers to the condenser at the back of the refrigerator in order to prevent leaning to the wall for good performance.
- If you will place your fridge next to your kitchen cabinets, leave a space of 2 cm between them.
- Install the distance adjustment plastic (the part with black vanes at the rear) by turning it 90° to prevent the condenser from touching the wall.
- The adjustable front legs should be stabilized in an appropriate height to allow your fridge to operate in a stable and proper way. You can adjust the legs by turning them clockwise (or in the opposite direction). This should be done before placing food in the fridge.
- Before using your fridge, wipe all parts with warm water added with a tea spoonful of sodium bicarbonate, and then rinse with clean water and dry. Place all parts after cleaning.

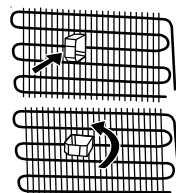

Before Using your Fridge

- When it is operated for the first time or after transportation, keep your fridge in the upright position for 3 hours and plug it on to allow efficient operation. Otherwise, you may damage the compressor.
- Your fridge may have a smell when it is operated for the first time; the smell will fade away when your fridge starts to cool.

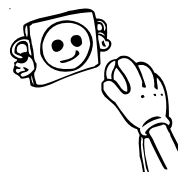

CHAPTER 2. USAGE INFORMATION

Thermostat Setting

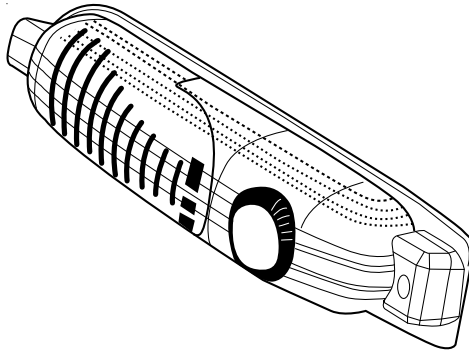

Larders (coolers) have not any freezer compartment but can cool below 5°C.

- Thermostat automatically regulates the inside temperature of the refrigerator compartment. By rotating the knob from position « 1 » to « 5 », colder temperatures can be obtained.
- « • » position shows thermostat is closed and no cooling is available.
- For short-term storage of food in the refrigerator compartment, you can set the knob between minimum and medium position.(1-3)
- For long-term storage of food in the refrigerator compartment, you can set knob to medium position.(3-4)
- **Note that; the ambient temperature, temperature of the freshly stored food and how often the door is opened, affects the temperature in the refrigerator compartment. If required, change the temperature setting.**
- *Larders (coolers) have not any freezer compartment but can below 5°C.*
- *When you first switch on the appliance, for starting a suitable cooling, the appliance should work 24 hours continuously until it cools down to sufficient temperature.*
- *In this time do not open the door so often and place a lot of food inside the appliance.*
- *If the unit is switched off or unplugged, you must allow at least 5 minutes before restarting or re-plugged the unit in order not to damage the compressor.*

CHAPTER 3. CLEANING AND MAINTENANCE

- Make sure to unplug the fridge before starting to clean it.

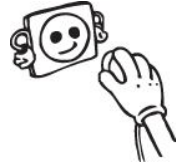

- Do not wash your fridge by pouring water.

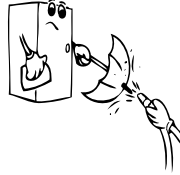

- You can wipe the inner and outer sides with a soft cloth or a sponge using warm and soapy water.

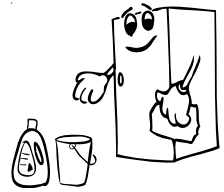

- Remove the parts individually and clean with soapy water. Do not wash in washing machine.

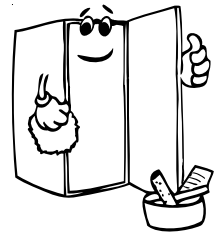

- Never use flammable, explosive or corrosive material like thinner, gas, acid for cleaning.

- You should clean the condenser with broom at least twice a year in order to provide energy saving and increase the productivity.

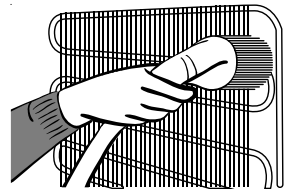

- ***Make sure that your fridge is unplugged while cleaning.***

Defrosting

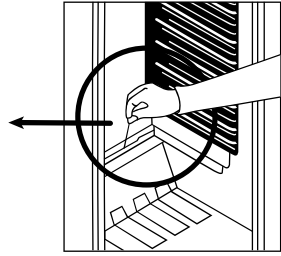
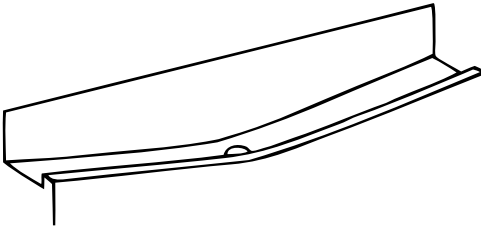

- Defrosting occurs automatically in refrigerator compartment during operation ; the defrost water is collected by the evaporating tray and evaporates automatically.
- The evaporating tray and the defrost water drain hole should be cleaned periodically with defrost drain plug to prevent the water from collecting on the bottom of the refrigerator instead of flowing out.
- You can also pour ½ glass of the water to drain hole to clean inside.

Replacing The Bulb

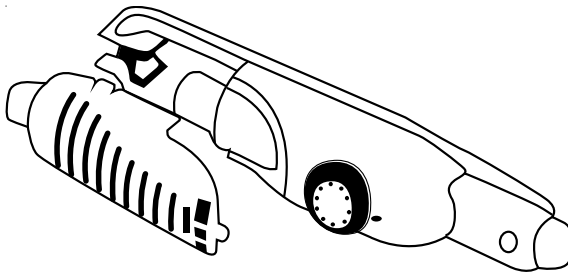

To replace the bulb in freezer and fridge departments;

- 1- Unplug your fridge.
- 2- Remove the cover of the box from the claws using a screwdriver.
- 3- Replace with a bulb of maximum 15 Watts.
- 4- Install the cover.
- 5- Wait for 5 minutes before re-plugging and bring the thermostat to its original position.

CHAPTER 4. SHIPMENT AND REPOSITIONING

- Original package and foam may be kept for re-transportation (optionally).
- You should fasten your fridge with thick package, bands or strong cords and follow the instructions for transportation on the package for re-transportation.
- Remove movable parts (shelves, accessories, vegetable bins etc.) or fix them into the fridge against shocks using bands during re-positioning and transportation.
- Carry your fridge in the upright position.

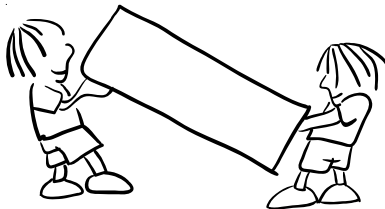

Repositioning the Door

- It is not possible to change the opening direction of your fridge door, if the door handles on your fridge are installed from the front surface of the door.
- It is possible to change the opening direction of the door on models without any handles.
- If the door opening direction of your fridge may be changed, you should contact the nearest Authorized Service to have the opening direction changed.

CHAPTER 5. BEFORE CALLING SERVICE

If your refrigerator is not working properly, it may be a minor problem, therefore check the following, before calling an electrician to save time and money.

What to do if your refrigerator does not operate ;

Check that ;

- There is no power,
- The general switch in your home is not disconnected ,
- The thermostat setting is on « • » position,
- The socket is not sufficient. To check this, plug in another appliance that you know which is working into the same socket.

What to do if your refrigerator performs poorly ;

Check that ;

- You have not overloaded the appliance ,
- The doors are closed perfectly ,
- There is no dust on the condenser ,
- There is enough place at the rear and side walls.

If there is noise ;

The cooling gas which circulates in the refrigerator circuit may make a slight noise(bubbling sound) even when the compressor is not running. Do not worry this is quite normal. If these sounds are different check that ;

- The appliance is well levelled ,
- Nothing is touching the rear ,
- The stuffs on the appliance are vibrating.

If there is water in the lower part of the refrigerator

Check that ;

The drain hole for defrost water is not clogged(Use defrost drain plug to clean the drain hole)

If your fridge is not cooling enough;

Your fridge is designed to operate in the ambient temperature intervals stated in the standards, according to the climate class stated in the information label. We do not recommend operating your fridge out of stated temperatures value limits in terms of cooling effectiveness.

Climate Class	Ambient Temperature (°C)
T	Between 16 and 43 (°C)
ST	Between 16 and 38 (°C)
N	Between 16 and 32 (°C)
SN	Between 10 and 32 (°C)

Recommendations

- In order to increase space **and improve the appearance, the « cooling section »** of refrigerators is positioned inside the back wall of the refrigerator compartment. When the appliance is running, this wall is covered with frost or water drops, when the compressor is running. Do not worry. This is quite normal. The appliance should be defrosted only if an excessively thick ice layer forms on the back wall.
- If the appliance is not used for a long time **(for example during the summer holidays).** **Set the thermostat knob to « 0 » position. Defrost and clean the refrigerator leaving the door open to prevent the formation of mildew and smell.**

Conformity Information

- Tropical Class is defined for the environment temperatures between 16°C and 43°C in accordance with the TS EN ISO 15502 Standards.
- The appliance is designed in compliance with the EN15502, IEC60335-1 / IEC60335-2-24, 2004/108/EC standards.

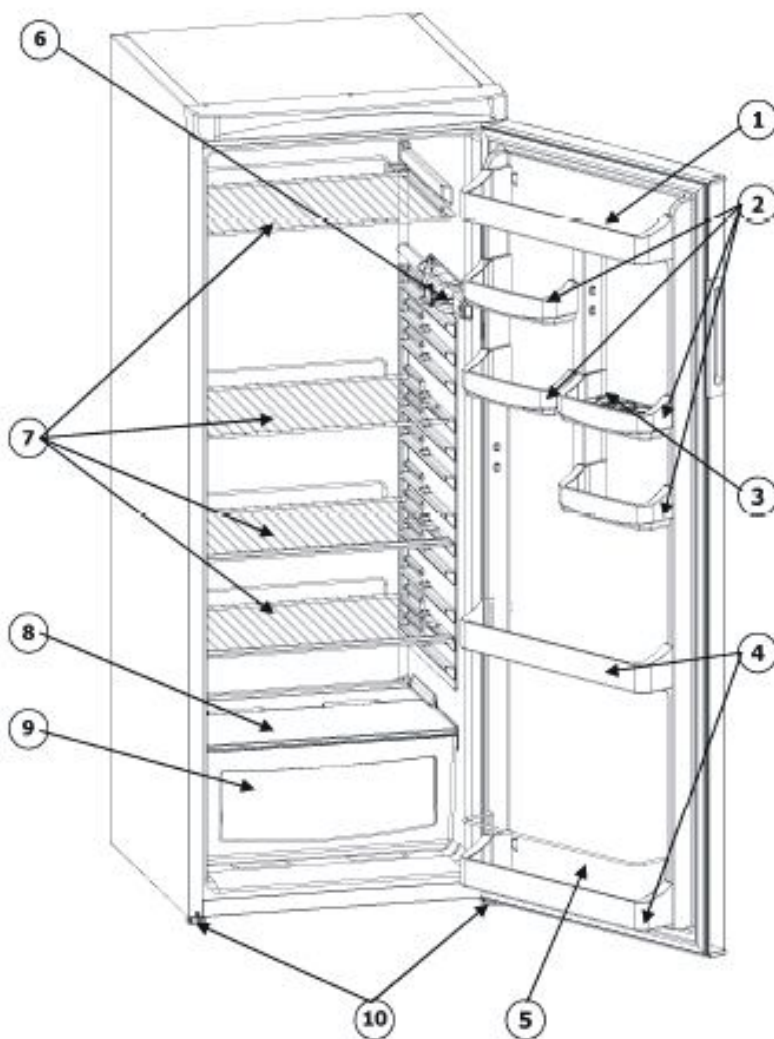
THE PARTS OF THE APPLIANCE AND THE COMPARTMENTS

This presentation is only for information about the parts of the appliance.
Parts may vary according to the appliance model.

- 1) TOP SHELF
- 2) EGG SHELF
- 3) EGG HOLDER
- 4) BOTTLE SHELF
- 5) BOTTLE HOLDER

- 6) THERMOSTAT BOX
- 7) REFRIGERATOR SHELF
- 8) CRISPER COVER(SAFETY GLASS*)
- 9) CRISPER
- 10) LEVELING FEET

ELECTRICAL CONNECTION (UK ONLY)

For your safety please read the following information

Warning: This appliance must be earthed.

This appliance operates from 220-240 volts and should be protected by a 13 amp fuse in the plug.

The appliance is supplied with a standard 13 amp 3-pin mains plug fitted with a 13-amp fuse. Should the fuse require replacement, it must be replaced with a fuse rated at 13 amp and approved to BS1362.

If the mains plug which is fitted is unsuitable for the socket outlet in your home or is removed for any other reason, please follow the instructions below on how to wire a 13 amp 3 pin plug..

How to wire a 13 amp plug.

Important

The wires in the mains lead on this appliance are coloured in accordance with the following code:

Green and Yellow - Earth

Blue – Neutral

Brown – Live

As the colours may not correspond with the markings identifying the terminals in your plug proceed as follows.

The green and yellow wire must be connected to the terminal in the plug which is marked with the letter E or with the earth symbol \perp or coloured green and yellow.

The blue wire must be connected to the terminal marked N.

The brown wire must be connected to the terminal marked L.

You must make sure the lead is firmly secured under the cord clamp.

